

Fire Fighter Safety Switch For Solar Building



BFS-S Series

Application

ZBENY The BFS-S Series Firefighter Safety Switch is a DC Isolation Solution for solar rooftop fire safety, providing DC power mechanical and complete isolation in the event of a fault. Make a safe area and operating space to protect the firefighter from DC electric shock. As the firefighter cut off the AC power in the house, the safety switch will disconnect the DC power at the same time.

- String Level Rapid Shutdown
- Up to 1500VDC, 50A per string
- Plug and Play for easy installation
- No cross-talk with inverter or Wifi
- Compatible with most string inverters and panels

Features





IP66 Aluminum enclosure with breathing valve

UI508i listed and IEC PV2 DC switch built-in

Genuine MC4 Plug and Play

Protection cover for rooftop installation is available

Specifications

Models	BFS-S			
Models	BFS-S1	BFS-S2	BFS-S3	BFS-S4
Number of Strings	1 string	2 strings	3 strings	4 strings
				
Max String Voltage(Vdc)	300V-1500V			
Max String Current(A)	50A			
Operating Voltage	90Vac-260Vac			
Nominal Voltage	230Vac			
Nominal Current	30mA			
Start up Current	average 100mA			
Switch on Action Current	Max 300mA			
Standard Compliance	IEC / EN 60947-3			
Protection Degree	IP66			
Storage Temperature Allowed Between	-40°C~+85°C			
Operating Temperature Range	-20°C~+50°C			
Maximum Operating Temperature Before Automatic Switch OFF	+85°C			
Protection Level	Class II			
Mechanical Endurance	9700			
Electrical Endurance	300			

Diagram

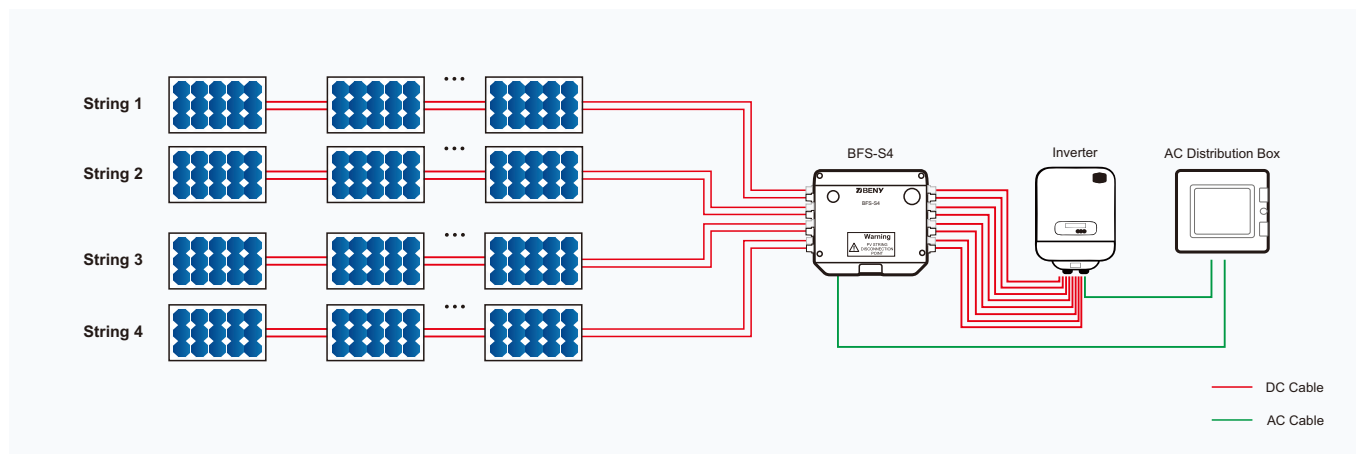

How the solution works?

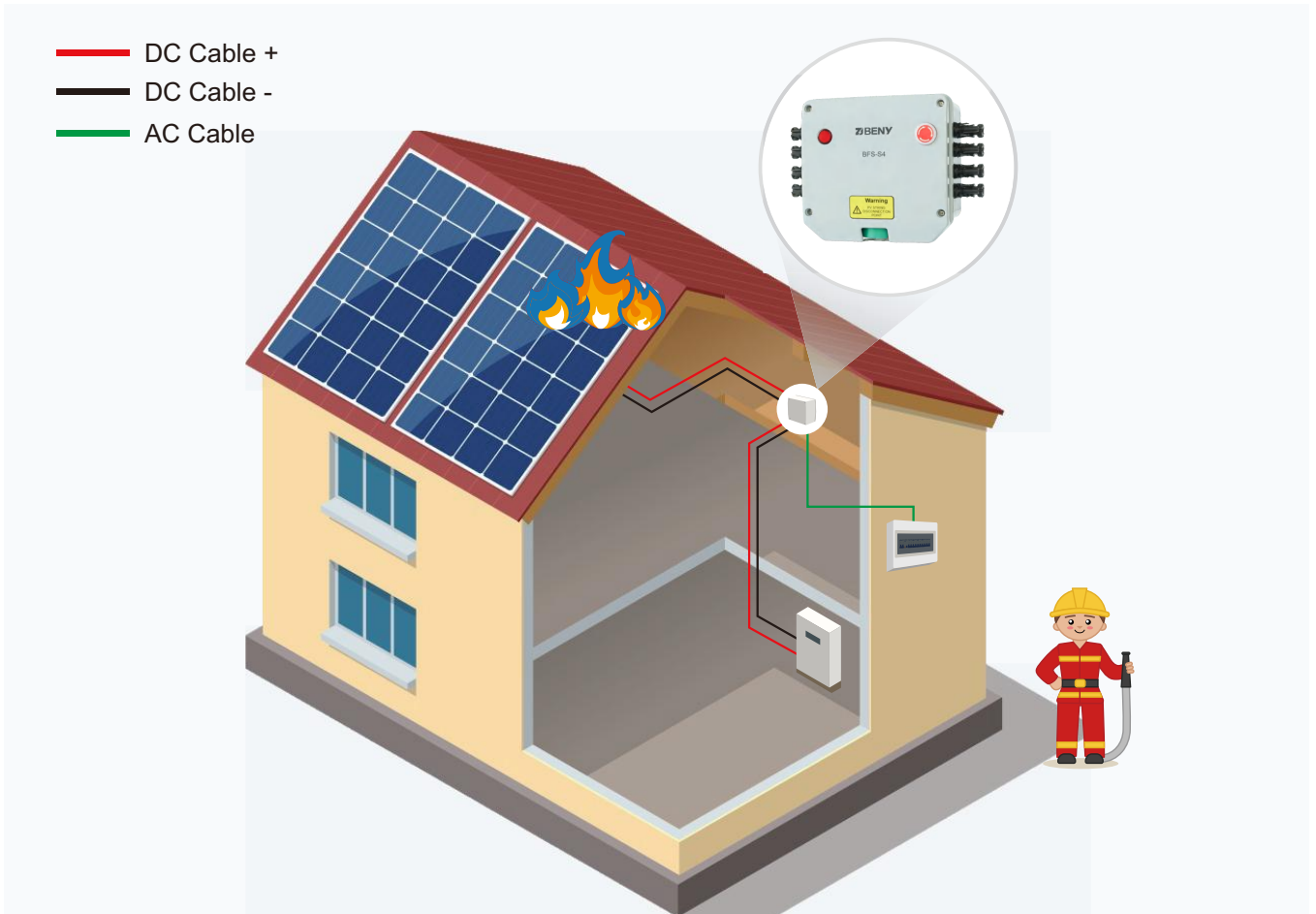

Shutdown Mode

Automatic Shutdown When Over Temperature

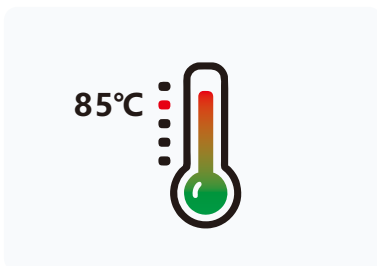

Automatically OFF the DC Power, when temperature inside of BFS-S enclosure $\geq 85^{\circ}\text{C}$.
Once temperature drop to $\leq 75^{\circ}\text{C}$, DC power will be back automatically.

Automatic Shutdown When AC Power Loss

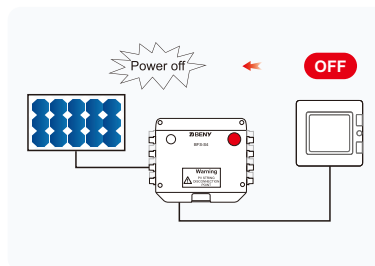

Automatically OFF the DC Power, when AC Power is loss accidentally or manually turn off by firefighter, so to make safety zone for firefighters.
Once AC Power is back, DC Power will be back automatically.

100% Shutdown By Emergency Button

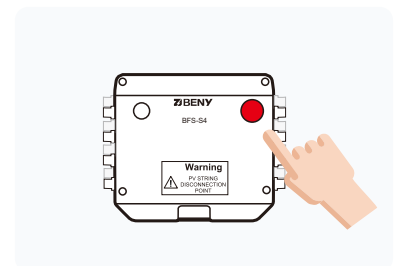

Press the emergency button to keep DC Power 100% OFF even when AC Power is back, so to keep a total safety zone for firefighters.

Dimensions

BFS-S Series Fire Safety Switch

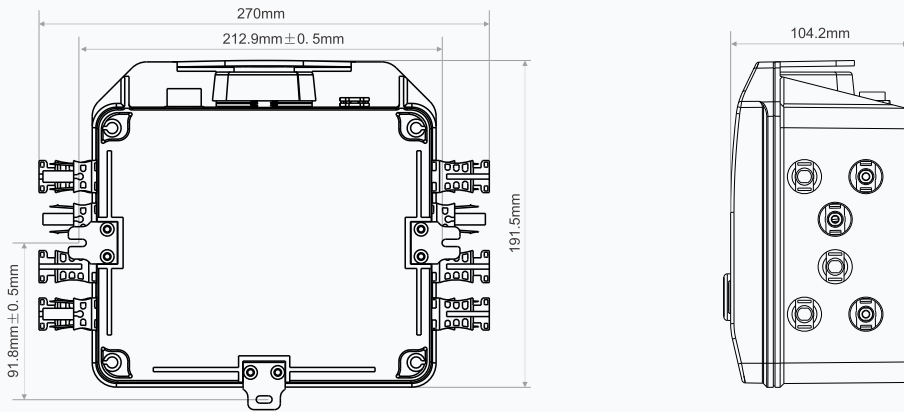

BFS-S Protection Cover for Fire Safety Switch

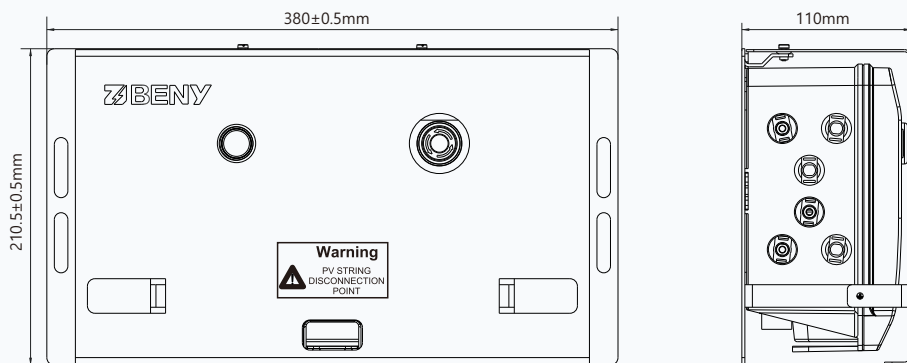

ZHEJIANG BENYI ELECTRICAL CO., LTD.

Address :Changjiang Rd, Wenzhou Daqiao Industry Park,

Beibaixiang Town, Yueqing, Wenzhou City, Zhejiang Province, China, 325600

TEL : +86-577-5717 7008 Email : benyi@zjbeny.com

VERSION : 20221118

For the latest version of specification, please refer to www.beny.com or contact to benyi@zjbeny.com
We reserve the right to explain the terms of specification.

